

DUAL OPERATIONAL AMPLIFIER

IL4560

GENERAL DESCRIPTION

The IL4560 integrated circuit is a high-gain, wide bandwidth, dual operational amplifier capable of driving 20 V peak-to-peak into 400 Ω loads. The IL4560 combines many of the features of the IL4558 as well as providing the capability of wider bandwidth, and higher slew rate make the IL4560 ideal for active filters, data and telecommunications, and many instrumentation applications.

FEATURES

- Operating Voltage ($\pm 4\text{ V} \sim \pm 18\text{ V}$)
- Wide Gain Bandwidth Product (10 MHz typ.)
- Slew Rate (4 V/μs typ.)
- Bipolar Technology

BLOCK DIAGRAM

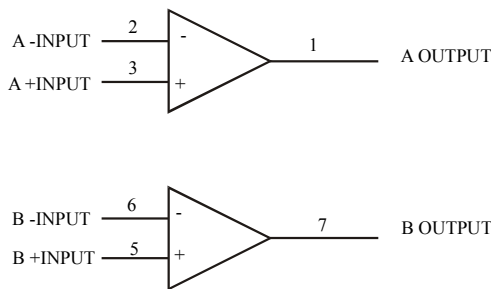

N SUFFIX PLASTIC

D SUFFIX SOIC

ORDERING INFORMATION
 IL4560N Plastic
 IL4560D SOIC
 $T_A = -40^\circ$ to 85° C
 for all packages.

PIN ASSIGNMENT

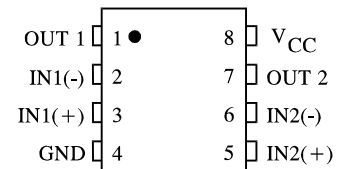

EQUIVALENT CIRCUIT (1/2 Show)

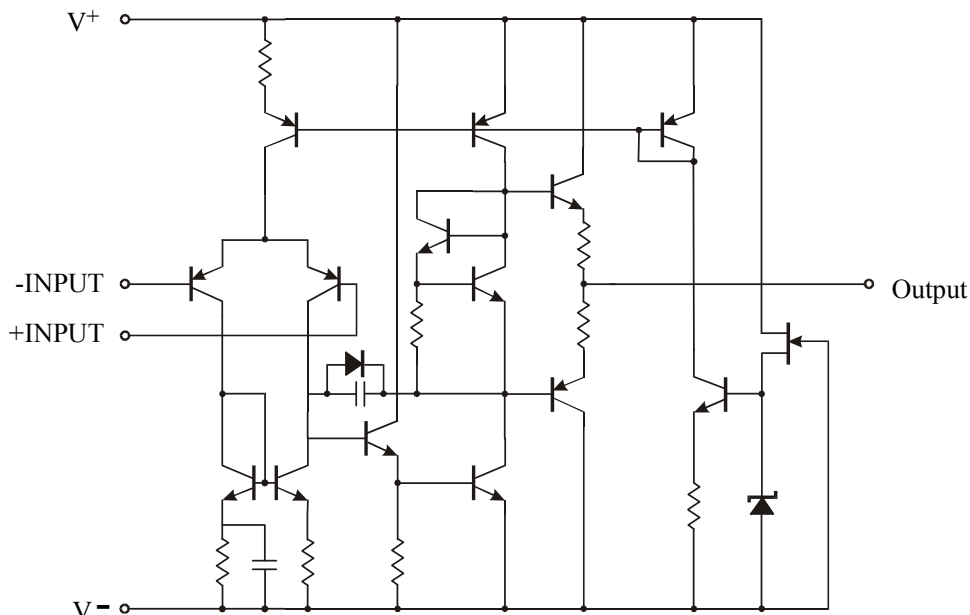

ABSOLUTE MAXIMUM RATINGS (Ta=25°C)

Symbol	Parameter	Ratings	Unit
V ⁺ /V ⁻	Supply Voltage	±18	V
V _{ID}	Differential Input Voltage	30	V
V _{IC}	Input Voltage	±15*	V
Topr	Operation Temperature Range	-40 ~ +85	°C
Tstg	Storage Temperature Range	-60 ~ +125	°C

* For supply voltage less than ±15 V, the absolute maximum input voltage is equal to the supply voltage.

ELECTRICAL CHARACTERISTICS (Ta=25°C, V⁺/V⁻ = ±15)

Symbol	Parameter	Test Condition	Min	Max	Unit
V _{IO}	Input Offset Voltage	R _S ≤ 10 kΩ	-	6	mV
I _{IO}	Input Offset Current		-	200	nA
I _B	Input Bias Current		-	500	nA
R _{IN}	Input Resistance		0.3	-	MΩ
A _V	Large Signal Voltage Gain	R _L ≥ 2 kΩ, V _O = ±10 V	86	-	dB
V _{OM1}	Maximum Output Voltage Swing 1	R _L ≥ 2 kΩ	±12	-	V
V _{OM2}	Maximum Output Voltage Swing 2	I _O = 25 mA	±10	-	V
V _{ICM}	Input Common Mode Voltage Range		±12	-	V
CMR	Common Mode Rejection Ratio	R _S ≤ 10 kΩ	70	-	dB
SVR	Supply Voltage Rejection Ratio	R _S ≤ 10 kΩ	76.5	-	dB
I _{CC}	Operating Current		-	5.7	mA
SR	Slew Rate	R _L ≥ 2 kΩ	3	5	V/μs

■ TYPICAL CHARACTERISTICS

Open Loop Voltage Gain vs. Frequency

($V^+/V^- = \pm 15V$, $R_L = 2k\Omega$, $T_a = 25^\circ C$)

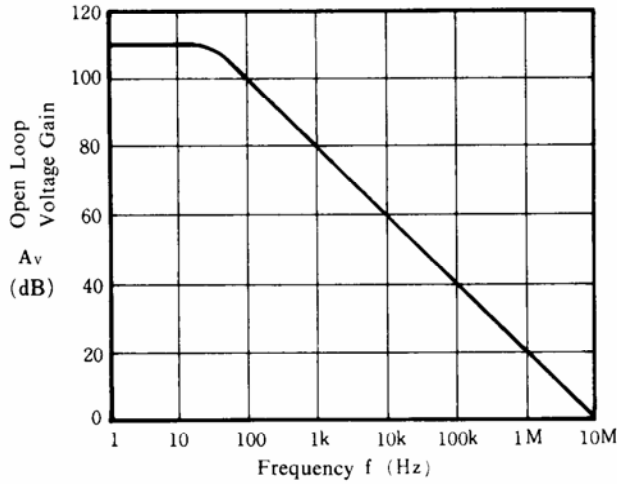

Maximum Output Voltage Swing vs. Frequency

($V^+/V^- = \pm 15V$, $T_a = 25^\circ C$)

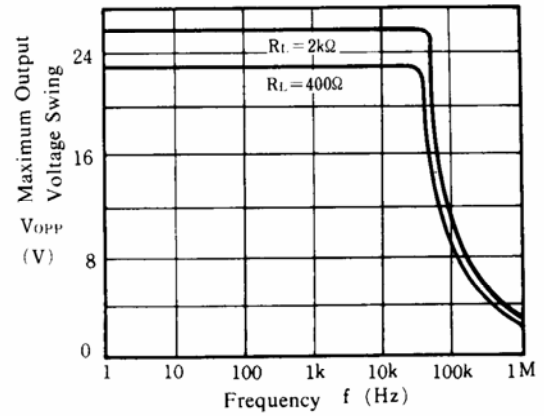

Maximum Output Voltage Swing vs. Load Resistance

($V^+/V^- = \pm 15V$, $T_a = 25^\circ C$)

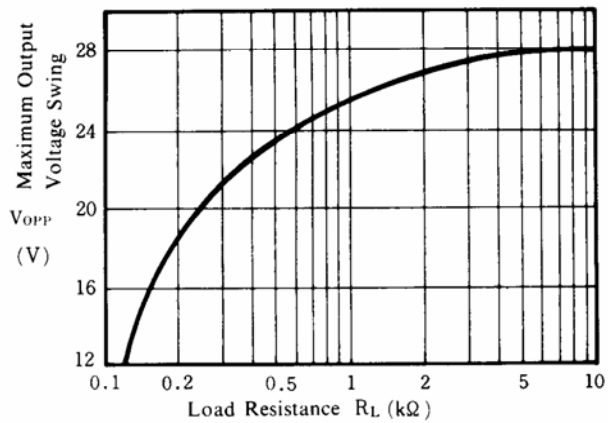

Equivalent Input Noise Voltage vs. Frequency

($V^+/V^- = \pm 15V$, $R_s = 50\Omega$, $A_v = 60dB$, $T_a = 25^\circ C$)

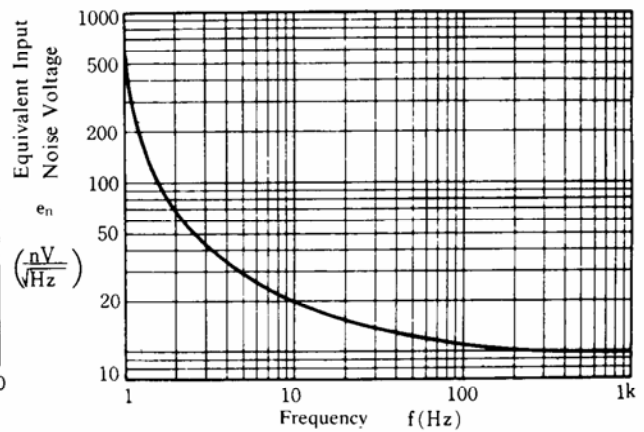

Operating Current vs. Temperature

($V^+/V^- = \pm 15V$)

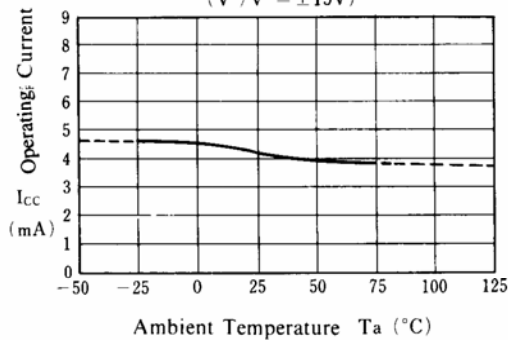

Maximum Output Voltage Swing vs. Temperature

($V^+/V^- = \pm 15V$, $R_L = 2k\Omega$)

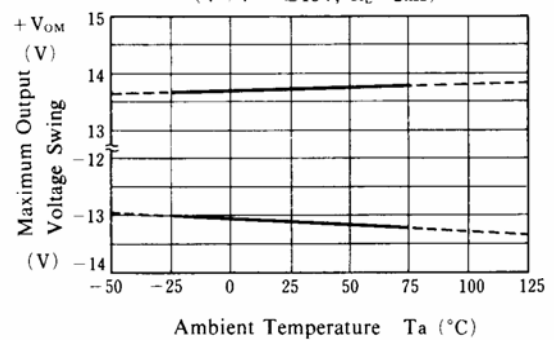

■ TYPICAL CHARACTERISTICS

Input Offset Voltage vs. Temperature

($V^+/V^- = \pm 15V$)

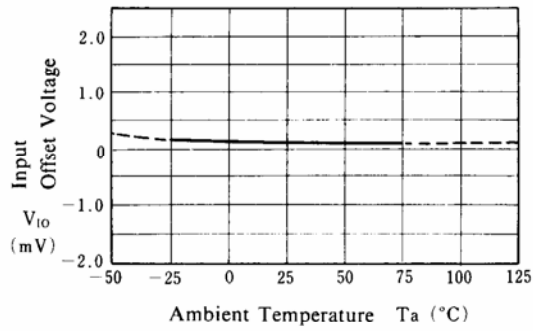

Input Bias Current vs. Temperature

($V^+/V^- = \pm 15V$)

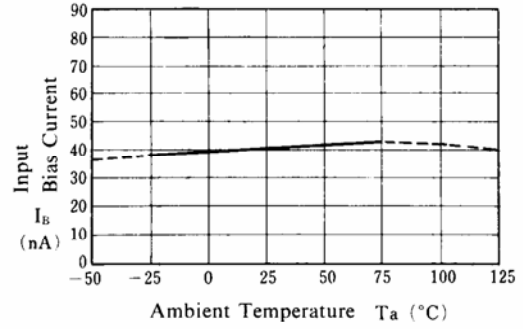

Maximum Output Voltage Swing vs. Supply Voltage

($R_L = 400\Omega$, $T_a = 25^\circ C$)

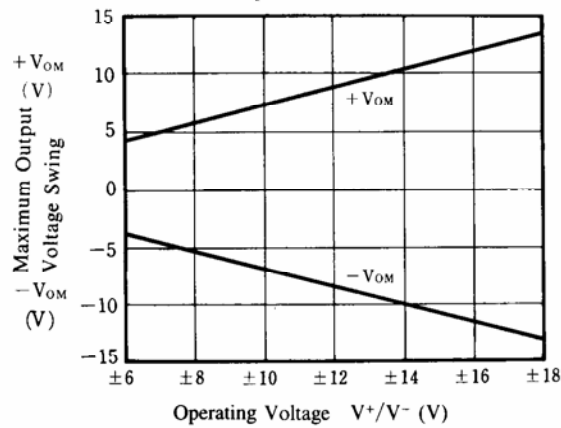

Operating Current vs. Operating Voltage

($T_a = 25^\circ C$)

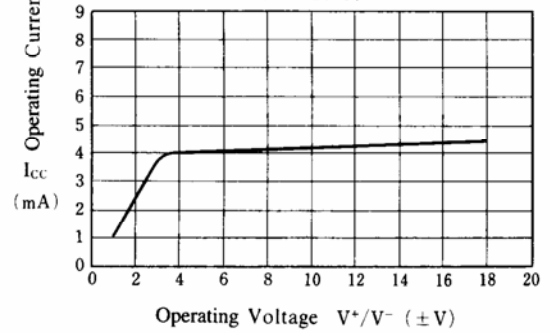

**N SUFFIX PLASTIC DIP
(MS – 001BA)**

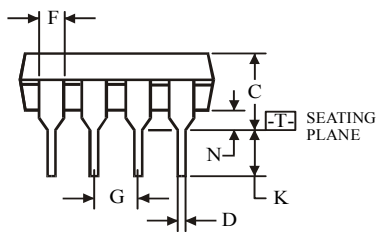
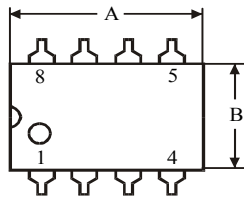
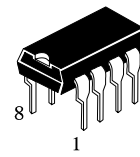

$\oplus 0.25 (0.010) \text{ (M) T}$

Symbol	Dimension, mm	
	MIN	MAX
A	8.51	10.16
B	6.1	7.11
C		5.33
D	0.36	0.56
F	1.14	1.78
G	2.54	
H	7.62	
J	0°	10°
K	2.92	3.81
L	7.62	8.26
M	0.2	0.36
N	0.38	

NOTES:

- Dimensions “A”, “B” do not include mold flash or protrusions.
Maximum mold flash or protrusions 0.25 mm (0.010) per side.

**D SUFFIX SOIC
(MS - 012AA)**

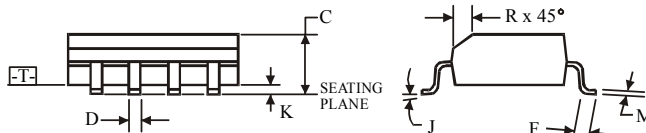
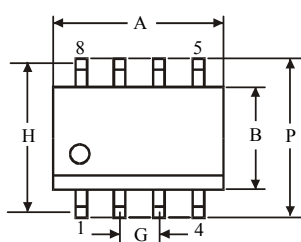
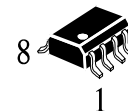

$\oplus 0.25 (0.010) \text{ (M) T C (M)}$

Symbol	Dimension, mm	
	MIN	MAX
A	4.8	5
B	3.8	4
C	1.35	1.75
D	0.33	0.51
F	0.4	1.27
G	1.27	
H	5.72	
J	0°	8°
K	0.1	0.25
M	0.19	0.25
P	5.8	6.2
R	0.25	0.5

NOTES:

- Dimensions A and B do not include mold flash or protrusion.
- Maximum mold flash or protrusion 0.15 mm (0.006) per side for A; for B - 0.25 mm (0.010) per side.